



VALVES

pressure operated
stainless steel body

with flanges PN40, DIN and ANSI Class 300, DN 15 to 50

NC

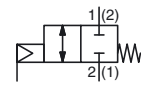

NO

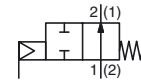

2/2
Series
T298

FEATURES

- Ruggedly built valve, particularly recommended for use with steam, superheated water, corrosive fluids
- High-performance, maintenance-free stuffing box, resistant to thermal shock
- Pressure can be applied to any port as needed by the process
- Anti-waterhammer design (fluid entry at orifice 1), recommended for use with liquids
- Vacuum operation up to 10^{-2} mbar
- Allowable backpressure: up to 40 bar
- Optical position indicator as standard
- Autoclavable valve for use at high ambient temperatures (up to 180°C)
- The valves satisfy Pressure Equipment Directive 97/23/EC, category 1 (DN > 32) or article 3.3 (DN \leq 32)

GENERAL

Differential pressure	0 to 40 bar [1 bar = 100 kPa]
Maximum allowable pressure	40 bar (within the specified limits, see diagram I)
Ambient temperature range	-25°C to $+180^{\circ}\text{C}$
Maximum viscosity	5000 cSt (mm^2/s)
Pilot fluid	Air
Max. pilot pressure	10 bar
Min. pilot pressure	See below



fluids (*)	temperature range	disc seal (*)
DN 15-20-25: air and gas groups 1 & 2 DN 32-40-50: air and gas group 2 all DN: water, oil, liquids groups 1 & 2 and steam	-10°C to $+250^{\circ}\text{C}$	bronze PTFE

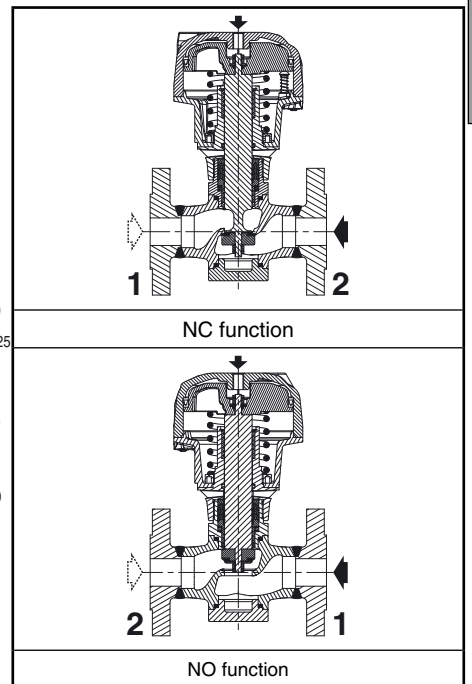
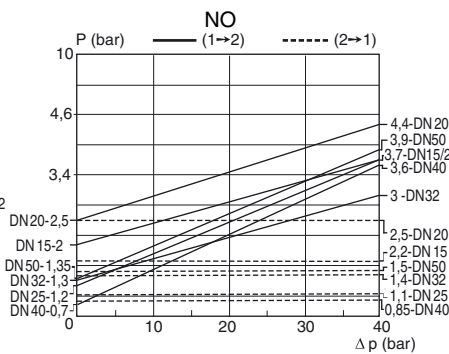
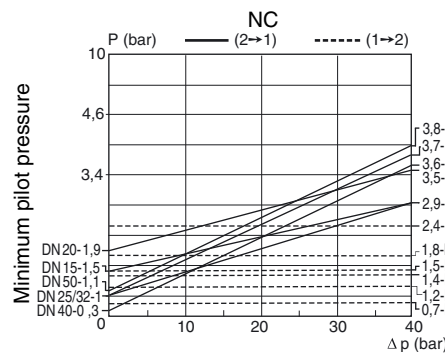

SPECIFICATIONS

Connection	Flanges PN40, type 21 (ISO 7005 / EN 1092) ANSI Class 300 ANSI B16-5
Face-to-face dimensions	EN 558-1
Face de joint	Type B

MATERIALS IN CONTACT WITH FLUID

(*) Ensure that the compatibility of the fluids in contact with the materials is verified

Body and plug	Stainless steel
Stuffing box housing	Stainless steel
Stem, disc	Stainless steel
Stuffing box packing	PTFE chevrons
Disc seal	Bronze PTFE
Valve body seal	Graphite

OTHER MATERIALS

Operator	Aluminium, nickel plated
----------	--------------------------

SPECIFICATIONS

DN	orifice size	flow coefficient Kv				pilot pressure (bar)		operating pressure differential (bar)	operator diameter (mm)	catalogue number	
		1 → 2		2 → 1		min.	max.			DIN	ANSI 300
		(m^3/h)	(l/min)	(m^3/h)	(l/min)						
NC - Normally closed											
15	15	4,4	73	5	83	*	10	40	80	T298A001	T298A013
20	20	7,7	128	8,5	142	*	10	40	100	T298A002	T298A014
25	25	11,5	192	12	200	*	10	40	100	T298A003	T298A015
32	32	18	300	18	300	*	10	40	150	T298A004	T298A016
40	40	29	483	29	483	*	10	40	150	T298A005	T298A017
50	50	57	950	57	950	*	10	40	200	T298A006	T298A018

* Minimum pilot pressure varies with differential pressure. See piloting chart above.

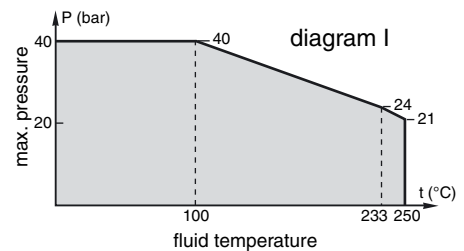

00173GB-2012/R01
Availability, design and specifications are subject to change without notice. All rights reserved.

SPECIFICATIONS

DN	orifice size (mm)	flow coefficient Kv				pilot pressure (bar)		operating pressure differential (bar)	operator diameter (mm)	catalogue number	
		1 → 2		2 → 1		min.	max.			DIN	ANSI 300
		(m³/h)	(l/min)	(m³/h)	(l/min)						
NO - Normally open											
15	15	3,5	58	3,5	58	*	10	40	80	T298A007	T298A019
20	20	7,2	120	7	117	*	10	40	100	T298A008	T298A020
25	25	11	183	11	183	*	10	40	100	T298A009	T298A021
32	32	18	300	15	250	*	10	40	150	T298A010	T298A022
40	40	28,2	470	28,2	470	*	10	40	150	T298A011	T298A023
50	50	53	883	53	883	*	10	40	200	T298A012	T298A024

* Minimum pilot pressure varies with differential pressure. See piloting chart above.

OPTIONS AND ACCESSORIES

- Metal-to-metal sealing disc
- Signaling box, with mechanical or inductive contacts
- Low ambient temperatures - Temperature range: -50°C to +70°C
- ATEX 94/9/EC versions for potentially explosive atmospheres, categories 2 GD and 3 GD
- 2 switches, Ex d protection, mounted on valve with 2 Crouzet contacts type 83101-I-W1, for use in ambient temperatures from -20°C to +80°C: suffix **SD2** [Contact us for option with 1 Honeywell contact type 1HS1 (-55°C to +82°C) or 1 Crouzet contact (-20°C to +80°C).]
- Valve seat leakage class VI as defined by FCI 70-2, contact us
- Other pipe connections are available on request

INSTALLATION

- The valves can be mounted in any position without affecting operation
- Compatible with ASTM 1, 2 and 3 oils
- Pipe connections (G*) have standard thread according to ISO 228/1 and ISO 7/1 Pipe connections (G) have standard thread according to ISO 228/1
- Installation/maintenance instructions are included with each valve

SPARE PARTS KITS

catalogue number	spare parts kit no.		
	piston seal	actuator spring	stem, disc, seals
T298A001/013	C140233	C140299	C140311
T298A002/014	C140234	C140301	C140313
T298A003/015	C140234	C140303	C140315
T298A004/016	C140235	C140305	C140317
T298A005/017	C140235	C140307	C140319
T298A006/018	C140298	C140309	C140321
T298A007/019	C140233	C140300	C140312
T298A008/020	C140234	C140302	C140314
T298A009/021	C140234	C140304	C140316
T298A010/022	C140235	C140306	C140318
T298A011/023	C140235	C140308	C140320
T298A012/024	C140298	C140310	C140322

ORDERING EXAMPLES:

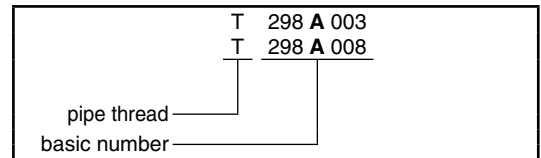

ORDERING EXAMPLES KITS:

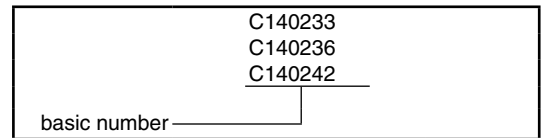

DIMENSIONS (mm), WEIGHT (kg)



TYPE 01-02-03-04

Prefix "T"

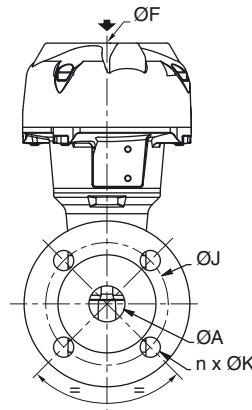
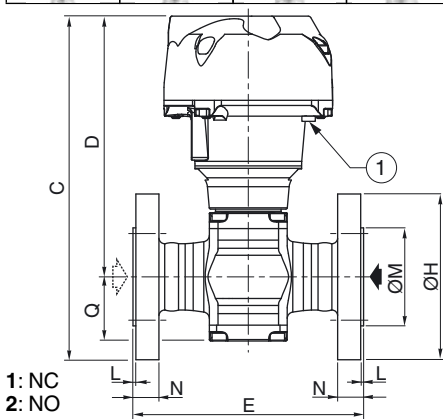

type	DN	operator diameter	weight			
			DIN		ANSI	
			NC	NO	NC	NO
01	15	80	3,3	3,3	3,2	3,2
	20	100	5,6	5,6	5,9	5,9
02	25	100	6,8	6,7	7,2	7,1
	32	150	13,2	13,2	13,2	13,3
03	40	150	16,4	16,4	17,2	17,2
	50	200	30,5	28,7	30,8	29

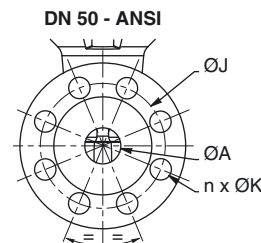

TOP VIEW

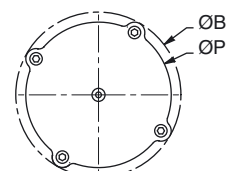

① Optical position indicator

type	DN	operator diameter	ØA	ØB	C		D	E		ØF	ØH		ØJ	n x ØK		L		ØM		N		ØP	Q
					DIN	ANSI		DIN	ANSI		DIN	ANSI		DIN	ANSI	DIN	ANSI	DIN	ANSI	DIN	ANSI		
01	15	80	15	110	199,1	151,6	130	140	G 1/8	95	65	66,5	4 x 14	4 x 16	2	1,6	45	35	16	14,2	95	32,5	
	20	100	20	132,5	223,4	170,9	150	170	G 1/8	105	120	75	82,5	4 x 14	4 x 19	2	1,6	58	43	18	15,8	117	39
02	25	100	25	132,5	238,4	180,9	160	170	G 1/8	115	125	85	89	4 x 14	4 x 19	2	1,6	68	51	18	17,5	117	44,5
	32	150	32	191	307,2	237,2	180	190	G* 1/4	140	135	100	98,5	4 x 18	4 x 19	2	1,6	78	64	18	19,1	172,5	54
03	40	150	40	191	334,2	259,2	200		G* 1/4	150	155	110	114,5	4 x 18	4 x 22	2	1,6	88	73	18	20,6	172,5	66,5
	50	200	50	247	411	328,5	230		G* 1/4	165	125	127	127	4 x 18	8 x 19	2	1,6	102	92	20	22,4	230	80,5

All leaflets are available on: www.asconumatics.eu